

IMPORTANT PARTS OF YOUR DA-LITE SCREEN

(When ordering parts, please specify screen model and size.)

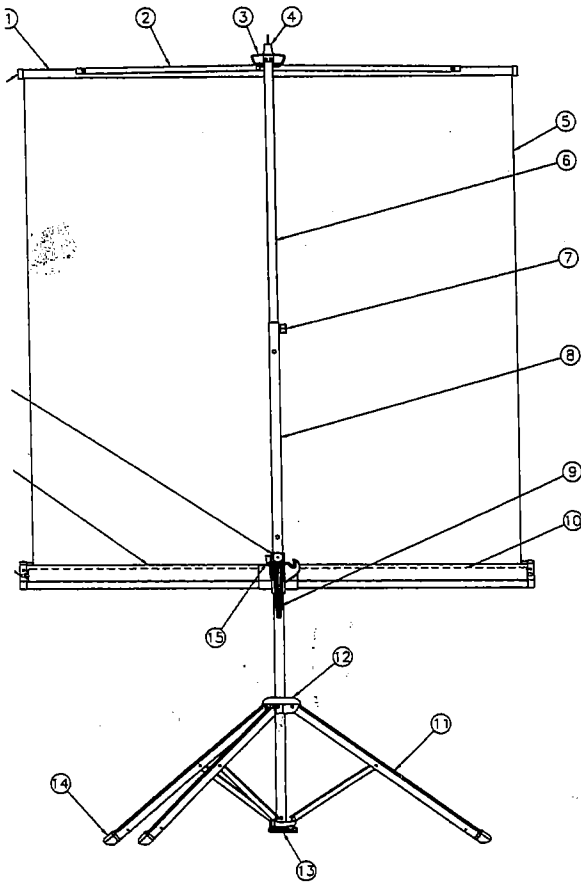

- | | |
|---------------------|-------------------------------|
| 1) Slat | 12) Leg Bracket |
| 2) Saddle | 13) Toe Release & Leg Lock |
| 3) Pull Bail | 14) Leg Shoes |
| 4) Hanger Hook | 15) Fabric Tension Lock Lever |
| 5) Picture Surface | 16) End-Cap |
| 6) Extension Tube | 17) Screen Case |
| 7) Red Locking Knob | 18) Red Locking Knob |
| 8) Bottom Tube | 19) Slat Caps |
| 9) Handle | |
| 10) Roller | |
| 11) Tripod | |

SETTING UP YOUR SCREEN

1. Hold screen vertically with tripod just above floor. With toe, press straight down on toe release plate. Tripod legs will glide open.
2. Pull out Red Locking Knob at top of bottom tube.
3. Raise extension tube to first position, and then swing case to horizontal position.
4. Raise screen surface and pull bail over hanger. If Keystone Eliminator is to be used, (1) simply grasp the knurled tip which protrudes slightly above the hanger; (2) pull straight up; (3) then lay in a horizontal position over the hanger, and place the pull bail on it.
5. Release Red Locking Knob and fabric tension lock lever on handle.
6. Holding extension tube with one hand and releasing Red Locking Knob with other, raise extension tube to desired position.
7. The case position may be changed by pulling out the Red Locking Knob located on the handle.
8. For rectangular picture area on screens with square surfaces, move case to desired position and lock by pressing down on the fabric tension lock lever.
9. On models with Super Wonder-Lite surface, press down on handle until surface is taut. Lock by pressing down on fabric tension locking lever.

USING SCREEN IN LOWEST POSITION

Follow steps 1 through 3 above.

- a. Raise locking lever on left side of handle.
- b. Release red knob and lower case.
- c. Holding bottom tube, raise extension tube until it locks into desired position.

CLOSING THE SCREEN

1. Return screen case to original central position on center tube. On models with Super Wonder-Lite surface, first release fabric tension lock lever on handle.
2. Hold extension tube firmly. Pull out top Red Locking Knob and lower extension tube to bottom position.
3. Unhook screen pull bail and complete re-rolling fabric into case.
4. If Keystone Eliminator has been used, simply raise it to a perpendicular position and push it back into the extension tube.
5. Swing case to vertical position. Note that fabric locks in.
6. Set tab on hanger in opening of case end cap. As extension tube locks, the case also is locked.
7. Place tip of middle finger of right hand in depression beneath leg bracket. Lift leg bracket sharply, at the same time applying a slight lift to entire unit with left hand. Note that legs are closed and locked, hanger, and extension tube and case are locked and surface is locked to provide for safe and comfortable carrying and storing.

PROTECT YOUR SCREEN

Before re-rolling surface into case, examine both front and back of surface to be sure they are free of foreign matter. A Da-Lite Screen case cover is a wise and economical investment.

**QUALITY FEATURES FOR BETTER PICTURES,
EASIER OPERATION, LONGER LIFE**

- Steel Saddle for Wrinkle-Free Picture Surface
- Camlok Metal Roller System
- Automatic Fabric Lock
- Self-Locking Extension Tube
- Extra Heavy Duty Tripod Assembly
- Heavy Gauge Aluminum Legs Support Extra Strong Center and Extension Tubes
- Exclusive Custom Recessed Keystone Eliminator
- Flat Back No-Rub Octagon Case
- High Impact Plastic End Caps
- Wide Range Height Adjustment
- Tension Lever Lock for Position Adjustment

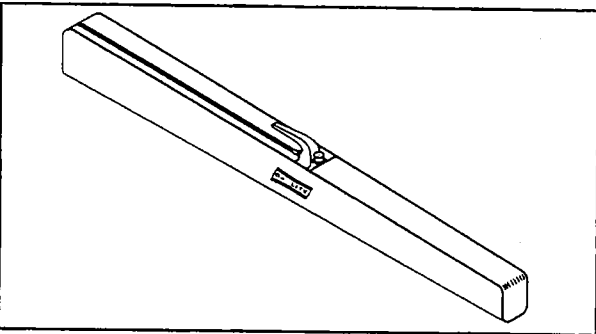

HEAVY DUTY CARRYING CASE

Will protect the screen's finish. Screen handle protrudes for easy carrying. Sizes available for all tripod screen models.

YOU HAVE MADE A WISE SELECTION...

in choosing a Da-Lite projection screen, designed and engineered to produce the sharpest, most pleasing pictures with maximum convenience.

**DA-LITE IS MORE
THAN PROJECTION SCREENS**

Da-Lite Tripod, Wall and Ceiling and Electric Screens

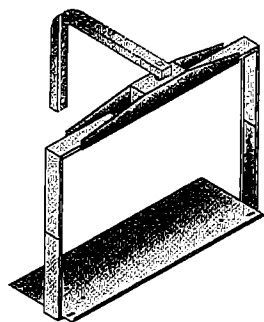
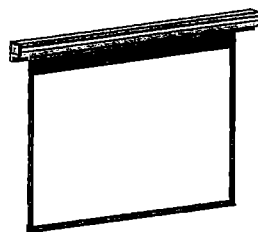

Da-Lite Monitor Mounts

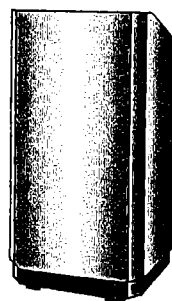

Da-Lite Lecterns



Da-Lite Project-O-Stands and Easels

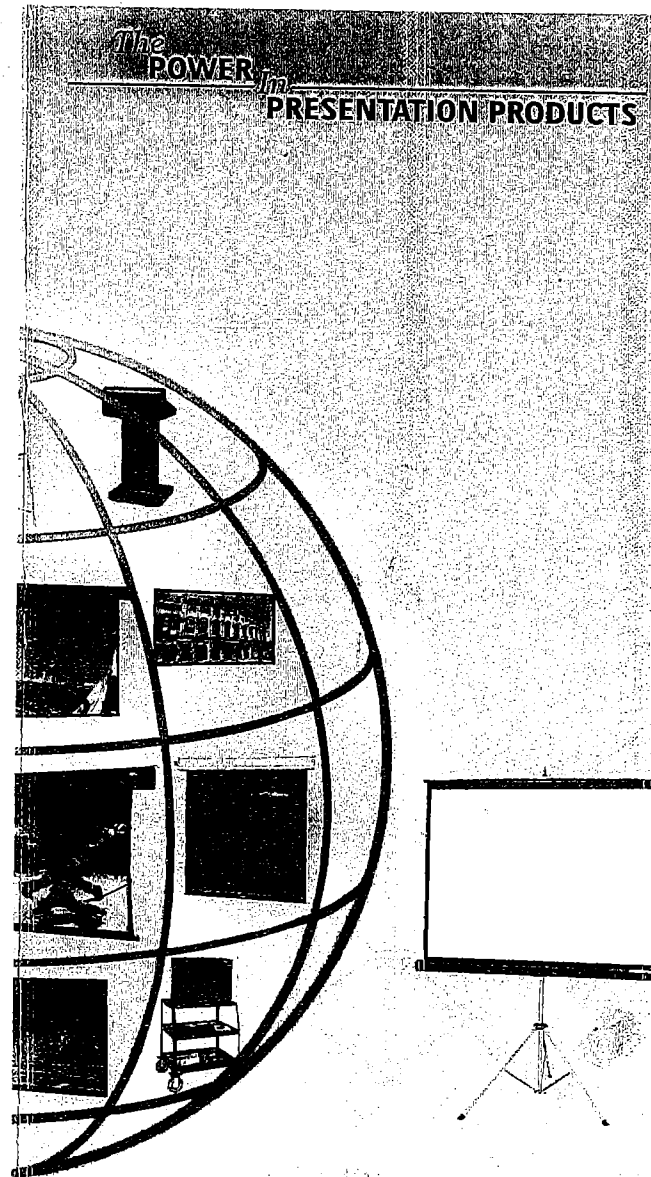
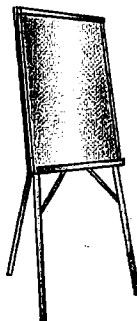

**Assembly Instructions
for
PICTURE KING**

DA-LITE SCREEN COMPANY, INC.
3100 North Detroit Street
Post Office Box 137
Warsaw, Indiana 46581-0137
Phone: 574/267-8101
800-622-3737
Fax: 574/267-7804
http://www.da-lite.com
e-mail: info@da-lite.com