



# Operator's Manual

## Ultra Buggy e2500

### Model—Serial Range

68037—400000000 and Up

68037G—400000000 and Up

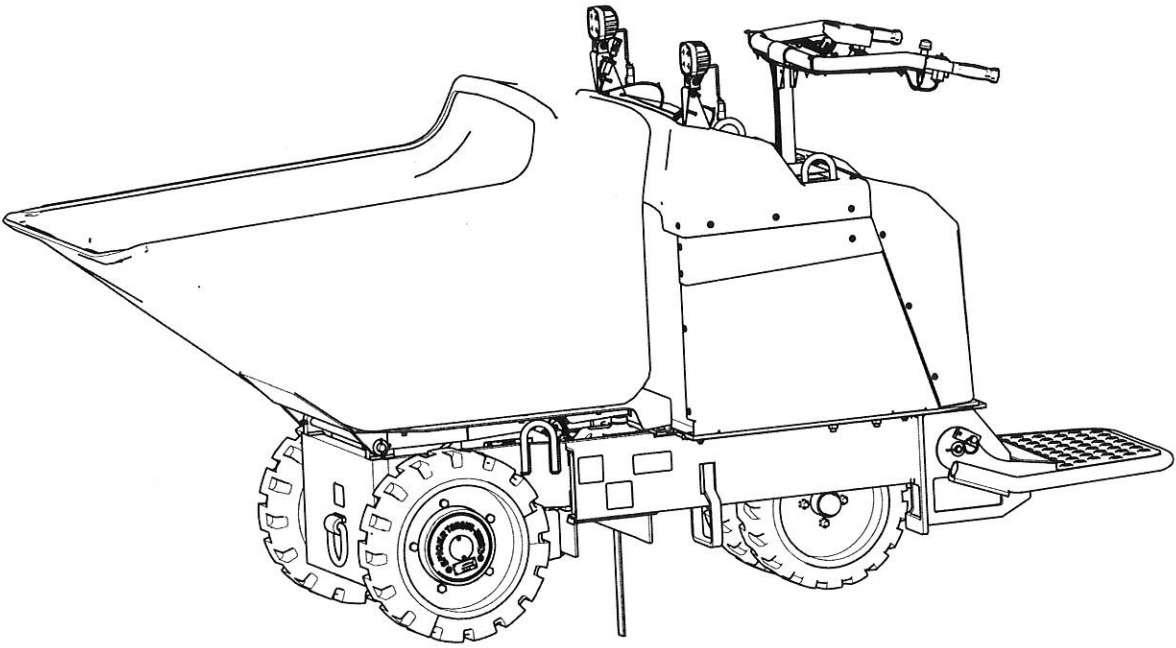

\* 3 4 6 5 - 6 8 3 \* A

# Disclaimers and Regulatory Information

## ▲ WARNING

### CALIFORNIA Proposition 65

The power cord on this product contains lead, a chemical known to the State of California to cause birth defects or other reproductive harm. Wash hands after handling.

Battery posts, terminals, and related accessories contain lead and lead compounds, chemicals known to the State of California to cause cancer and reproductive harm. Wash hands after handling.

Use of this product may cause exposure to chemicals known to the State of California to cause cancer, birth defects, or other reproductive harm.

## FCC

This device complies with Part 15 of the FCC Rules. Operation is subject to the following conditions: (1) this device may not cause harmful interference, and (2) this device must accept any interference received, including interference that may cause undesired operation. Changes or modifications not expressly approved by Toro could void the user's authority to operate the equipment.

In addition, while in charging mode this equipment has been tested and found to comply with the limits for a Class B digital device, pursuant to Part 15 of the FCC rules. These limits are designed to provide reasonable protection against harmful interference in a residential installation. This equipment generates, uses and can radiate radio frequency energy and, if not installed and used in accordance with the instructions, may cause harmful interference to radio communications. However, there is no guarantee that interference will not occur in a particular installation. If this equipment does cause harmful interference to radio or television reception, which can be determined by turning the equipment off and on, the user is encouraged to try to correct the interference by one or more of the following measures:

- Reorient or relocate the receiving antenna.
- Increase the separation between the equipment and receiver.
- Connect equipment into an outlet on a circuit different from that to which the receiver is connected.
- Consult the dealer or an experienced radio/TV technician for help.



## Intended Use

This machine is intended to be used by professional, hired operators on indoor and outdoor improved surfaces in commercial applications. It is primarily designed to move concrete, mortar, gravel, dirt, or debris around job sites. Using this product for purposes other than its intended use could prove dangerous to you and bystanders.

Read this information carefully to learn how to operate and maintain your product properly and to avoid injury and product damage. You are responsible for operating the product properly and safely.

## Getting Help

Visit [www.Toro.com](http://www.Toro.com) for product safety and operation training materials, accessory information, help finding a dealer, or to register your product.

Whenever you need service, genuine Toro parts, or additional information, contact an Authorized Service Dealer or Toro Customer Service and have the model and serial numbers of your product ready. These numbers are located on the serial plate on your product ①. Write the numbers in the space provided.

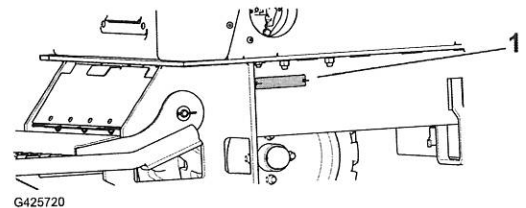

---

### IMPORTANT

---

With your mobile device, you can scan the QR code on the serial number decal (if equipped) to access warranty, parts, and other product information.

<b>Model Number:</b>		<b>Serial Number:</b>	
----------------------	--	-----------------------	--

**Product Overview**

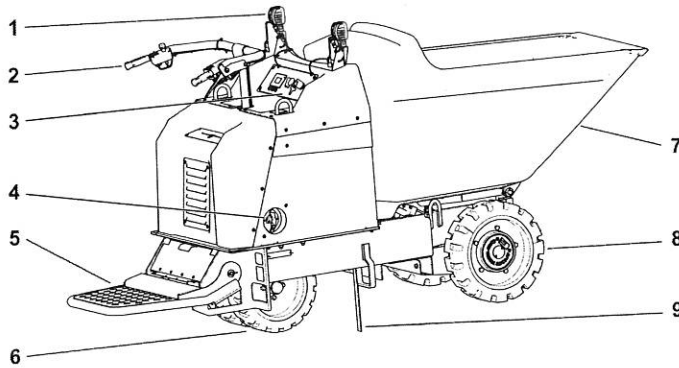

G380315

- ① Work lights
- ② Handle bars
- ③ Control panel
- ④ Electrical service disconnect switch
- ⑤ Operator platform
- ⑥ Steering tires
- ⑦ Hopper
- ⑧ Drive tires
- ⑨ Anti-static strap

**Controls**

**Electrical Service Disconnect Switch**

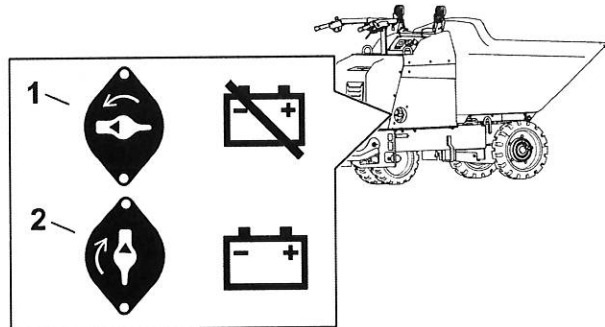

G387210

- ① Off—to de-energize the machine electrically
- ② On—to energize the machine electrically

## Directional Switch

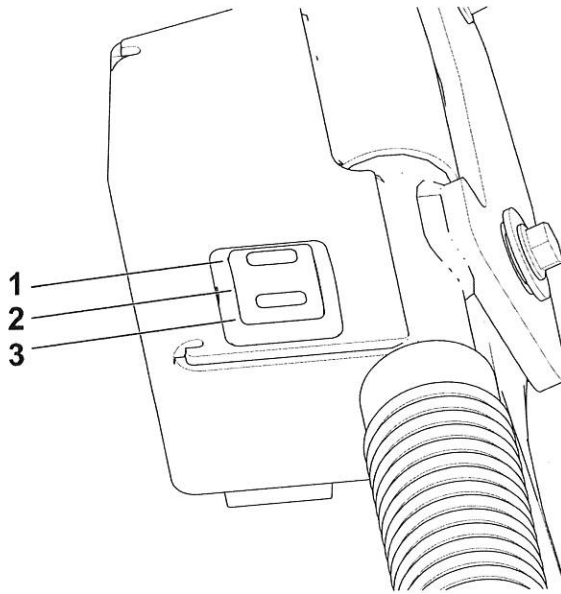

G380320

- ① Drive forward
- ② Neutral
- ③ Drive backward

## Dump Controls

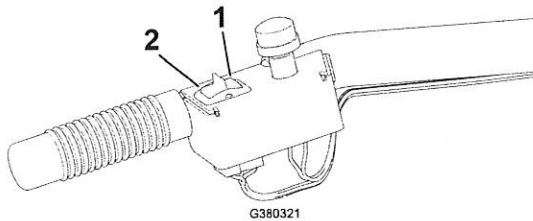

G380321

- ① Dump hopper
- ② Lower hopper

## Emergency Stop

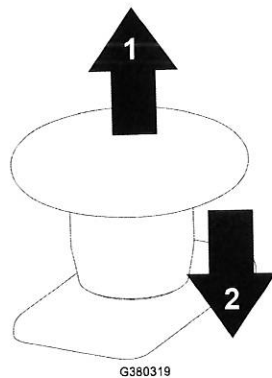

G380319

- ① Pull to enable the machine.

**Note:** Turn the key to the OFF then ON position to continue operating the machine.

- ② Push to immediately shut off the machine.

# Key Switch

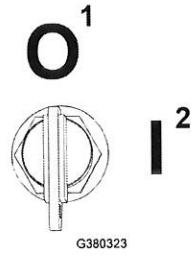

- ① Turn the machine off.
- ② Turn the machine on.

# Light Switch

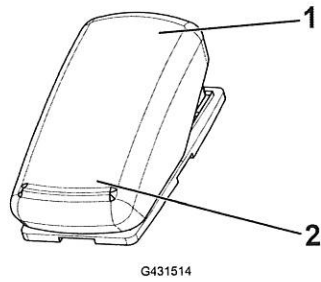





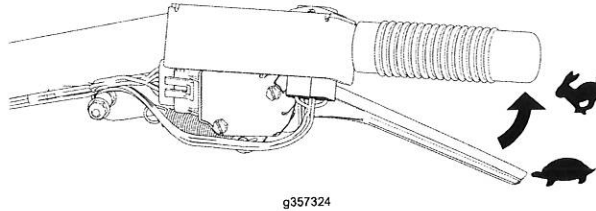





- ① Off
- ② On

# Throttle Control



# Display

## Display Icon Descriptions

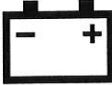
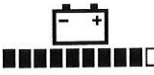
Icon	Description
	Menu access
	Next
	Previous
	Scroll down
	Enter
	Increase
	Decrease
	Exit menu
	Check PIN entry
	Parking brake is engaged.
	Hour meter
	Battery voltage
	Battery charge—each solid bar represents the change in 10% increments.

## Display (continued)

### Display Main Menu

Menu Item	Description
<b>Faults</b>	A list of the recent machine faults. Refer to the Service Manual or your Authorized Service Dealer for more information on the faults menu.
<b>Service</b>	Machine information such as hours of use and other similar numbers.
<b>Diagnostics</b>	Displays the state of each machine switch, sensor, and control output. This tells you which machine controls are on and off which assists in troubleshooting.
<b>Settings</b>	Customize and modify configuration variables on the InfoCenter display.
<b>About</b>	Lists the model number, serial number, and software version.

### Display Faults Menu

Menu Item	Description
<b>Current</b>	Lists the total number of key-on hours (i.e., hours that the key has been in the ON position).
<b>Last</b>	Indicates the last key-on hour that the fault occurred on.
<b>First</b>	Indicates the first key-on hour that the fault occurred on.
<b>Occurrences</b>	Indicates the number of fault occurrences.

### Display Service Menu

Menu Item	Description
<b>Hours</b>	Lists the total number of hours that the key and motor have been on and the traction controls have been engaged.
<b>Counts</b>	Lists the number of times the motor has been started and the amperage hours for the battery.
<b>Traction Pedal</b>	Lists the steps to calibrate the traction pedal.
<b>Steering Wheel</b>	Lists the steps to calibrate the steering wheel.



# Display (continued)

## Display Diagnostics Menu

Menu Item	Description
Battery	Indicates the inputs and outputs for the battery. Inputs include the current battery voltage; outputs include the battery current and percentage state of charge.
Left Motor	Indicates the speed and current of the left motor.
Right Motor	Indicates the speed and current of the right motor.

## Display Settings Menu

Menu Item	Description
Units	Indicates the inputs and outputs for the battery. Inputs include the current battery voltage; outputs include the battery current and percentage state of charge.
Language	Controls the language used on the InfoCenter.
Brightness	Controls the brightness of the LCD display.
Contrast	Controls the contrast of the LCD display.
Protected Menus	Allows you to access protected menus by inputting a passcode.

## Display About Menu

Menu Item	Description
Model	Lists the model number of the machine.
Serial	Lists the serial number of the machine.
Software	Lists the part number and software revision.
Left Motor	Lists the part number and software revision of the motor controller.
Battery	Lists the part number software revision of the battery

# Specifications

**Note:** Specifications and design are subject to change without notice.

Width (single wheel)	80.65 cm (31.75 inches)
Width (dual wheels)	106.7 cm (42 inches)
Length (with the platform up)	241.3 cm (95 inches)
Length (with the platform down)	282 cm (111 inches)
Height	139.7 cm (55 inches)
Weight	694 kg (1,530 lb)
Hopper capacity	0.40 m <sup>3</sup> (14 ft <sup>3</sup> )
Maximum load	1136 kg (2,500 lb)
Wheelbase	104 cm (41 inches)
Discharge height	16.5 cm (6.5 inches)

## Attachments/Accessories

A selection of Toro approved attachments and accessories is available for use with the machine to enhance and expand its capabilities. Contact your Authorized Service Dealer or authorized Toro distributor or go to [www.Toro.com](http://www.Toro.com) for a list of all approved attachments and accessories.

To ensure optimum performance and continued safety certification of the machine, use only genuine Toro replacement parts and accessories.



## Before Operation

### Before Operation Safety

#### Before Operation General Safety

- Never allow children or untrained people to operate the machine. Local regulations may restrict the age of the operator. The owner is responsible for training all operators and mechanics.
- Keep bystanders and children out of the operating area. Allow only people who are responsible, trained, familiar with the instructions, and physically capable to operate the machine.
- Become familiar with the safe operation of the equipment, operator controls, and safety signs.
- Inspect the area where you will use the machine and remove all objects that could interfere with the operation of the machine.
- Know and mark the locations of all utility lines.
- Check that the operator's presence controls, safety switches, and shields are attached and functioning properly. Do not operate the machine unless they are functioning properly.
- Locate the pinch point areas marked on the machine and keep hands and feet away from these areas.
- Before each work shift, inspect the machine components: the tires; warning devices; lights; battery; speed and directional controllers; brakes; safety interlocks; and steering mechanism. If the machine needs repair or is in any way unsafe, report it immediately and do not use the machine until it has been restored to safe operating condition.
- Identify sharp turns, blind spots, bridge approaches, and other potentially hazardous areas with a suitable warning to operators of the nature of the hazard and stating the proper precautions for them to take to avoid the hazard.
- Use only an approved machine in hazardous locations, as defined in the appropriate safety standards.
- Do not carry passengers on the machine and keep bystanders and children out of the operating area.
- Ensure that the area is clear of bystanders before operating the machine. Shut off the machine if a bystander enters the area.
- Keep away from potential hazards, such as edges of ramps and platforms.

## Before Operation Safety (continued)

- Park the machine on a level surface, engage the parking brake (if applicable), and shut off the machine. Wait for all movement to stop and allow the machine to cool before adjusting, servicing, cleaning, or storing the machine.

## Performing Daily Maintenance

Before starting the machine each day, perform the Each Use/Daily procedures listed in the Maintenance Schedule.

## During Operation

### During Operation Safety

#### During Operation General Safety

- The owner/user can prevent and is responsible for accidents that may cause personal injury or property damage.
- Do not exceed the rated operating capacity, as the machine may become unstable, which may result in loss of control.
- Wear appropriate clothing, including eye protection; long pants; substantial, slip-resistant footwear; and hearing protection. Tie back long hair and do not wear loose clothing or loose jewelry.
- Use your full attention while operating the machine. Do not engage in any activity that causes distractions; otherwise, injury or property damage may occur.
- Do not operate the machine while ill, tired, or under the influence of alcohol or drugs.
- Operate the machine only in good light, keeping away from holes and hidden hazards.
- Ensure that all drives are in the Neutral position before starting the machine. Start the machine only from the operating position.
- Keep your hands and feet away from moving parts. If possible, do not make adjustments with the machine running.
- Do not jerk the controls; use a steady motion.
- Use care when approaching blind corners, shrubs, trees, or other objects that may obscure your vision.
- Slow down and use caution when making turns and crossing roads and sidewalks with the machine. Always yield the right of way.
- Never leave a running machine unattended.
- Operate the machine only in appropriate weather conditions. Do not operate the machine when there is the risk of lightning.
- Be aware of obstacles in close proximity to you. Failure to maintain adequate distance from trees, walls, and other barriers may result in injury as the machine backs up during operation if you are not attentive to the surroundings.
- Check for overhead clearance (i.e., electrical wires, branches, and doorways) before driving under any objects and do not contact them.

## During Operation Safety (continued)

- Do not overload the hopper and always keep the load level when operating the machine.
- Avoid operating the machine on loose terrain. Loose terrain could cause the machine to lose traction, affecting steering, stability, and braking.
- Do not operate the vehicle in a dangerous manner, such as stunt driving or horseplay.
- Do not deliberately drive the machine over loose objects, potholes, or bumps.
- Observe all traffic regulations, including authorized speed limits. Under normal traffic conditions, keep to the right. Maintain a safe distance, based on speed of travel, from a machine or vehicle ahead; and keep the machine under control at all times.
- Park the machine on a level surface, lower the hopper, shut off the machine, and remove the key before leaving the operating position.
- Report all accidents involving personnel, building structures, and equipment.
- If during the machine becomes unsafe to use in any way, report it immediately. Do not use the machine until it has been restored to safe operating condition.

## Slope Safety

- Slopes are a major factor related to loss-of-control and tip-over accidents, which can result in severe injury or death. You are responsible for safe slope operation. Operating the machine on any slope requires extra caution. Before using the machine on a slope, do the following:
  - Review and understand the slope instructions in the manual and on the machine.
  - Evaluate the site conditions of the day to determine if the slope is safe for machine operation. Always use common sense and good judgment when performing this evaluation. Changes in the terrain, such as moisture, can quickly affect the operation of the machine on a slope.
- Raising the hopper on a slope affects the stability of the machine. Keep the hopper in the lowered and straight position when on slopes.
- Identify hazards at the base of the slope. Do not operate the machine near drop-offs, ditches, embankments, water or other hazards. The machine could suddenly roll over if a wheel or track goes over the edge or the edge collapses. Keep a safe distance (twice the width of the machine) between the machine and any hazard.
- Avoid starting, stopping, or turning the machine on a slope. Avoid making sudden changes in speed or direction; turn slowly and gradually.
- Keep all movements on slopes slow and gradual. Do not make sudden changes in speed or direction.
- Do not operate the machine under any conditions where traction, steering, or stability is in question. Be aware that operating the machine on wet grass, across slopes or downhill may cause the machine to lose traction. Loss of traction to the wheels or tracks may result in sliding and a loss of braking and steering. The machine can slide even if the wheels or tracks are stopped.
- Remove or mark obstacles such as ditches, holes, ruts, bumps, rocks or other hidden hazards. Tall grass can hide obstacles. Uneven terrain could overturn the machine.
- If you lose control of the machine, step off and away from the direction of travel of the machine.

# Starting the Machine

1. Ensure that the battery-disconnect switch is in the ON position.
2. Stand on the platform.
3. Insert the key into the key switch and turn it to the ON position.

**Note:** The machine may have difficulty starting under severe cold conditions. When starting a cold machine, keep the machine above  $-7^{\circ}\text{C}$  ( $20^{\circ}\text{F}$ ).

# Shutting off the Machine

1. Park the machine on a level surface.
2. Put the drive controls in the NEUTRAL position.
3. Turn the key switch to the OFF position and remove the key.

# Operating the Machine

1. Step onto the machine.



**When mounting the machine, slippery or uneven ground may cause you to fall. Always have 3 out of 4 arms/legs in contact with the machine when you mount or dismount the machine.**

2. Turn the key to the ON position.
3. Move the switch in the desired direction:
  - Forward ①—push the top of the switch.
  - Backward ③—push the bottom of the switch.

**Note:** Toggle the switch back to Neutral if it is in the forward or backward position when turning the machine on.

The more you squeeze the handle, the faster the machine travels.

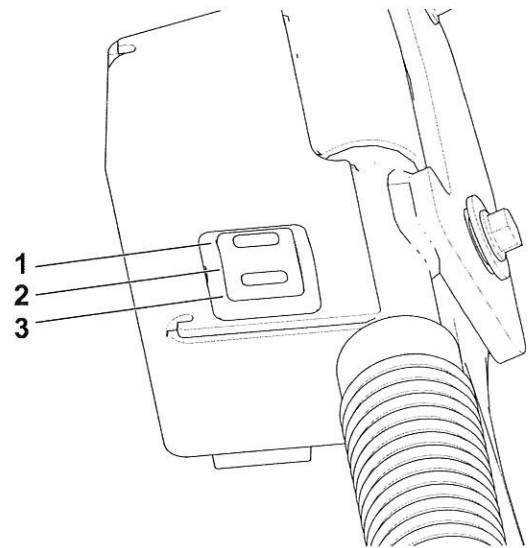

G380320

## Operating the Machine (continued)

4. Release the speed control handle to stop the machine.
5. Put the drive controls in the NEUTRAL ② position and turn the key switch to the OFF position.

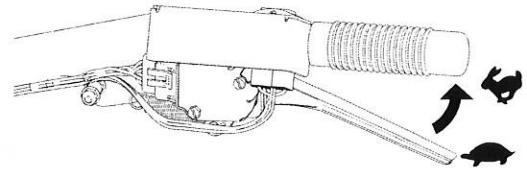

G380322

## Operator Platform

You can use the machine with the platform in the up or down position.



### WARNING



The operator platform is heavy and may cause injury when you raise or lower it. Carefully lower or raise the operator platform, as suddenly dropping it could injure you.

- Do not put your hands or fingers in the platform-pivot area when lowering or raising the operator platform.
- Make sure that the platform is supported when you pull the latch pin out.
- Make sure that the latch secures the platform when folding it up. Push it tight against the cushion for the latch pin to lock into place.
- Keep bystanders away from the machine when raising or lowering the platform.

Operate the machine with the platform up for the following conditions:

- Using the machine near drop-offs
- Using the machine in small areas where the machine is too large
- Areas with low-hanging branches or obstacles
- When loading or unloading the machine from a trailer for transport
- Driving up slopes

Operate the machine with the platform down for the following conditions:

- Using the machine in most areas
- Driving across slopes
- Driving down slopes

# Operator Platform (continued)

## Raising the Platform

Rotate the platform up until it locks into position.

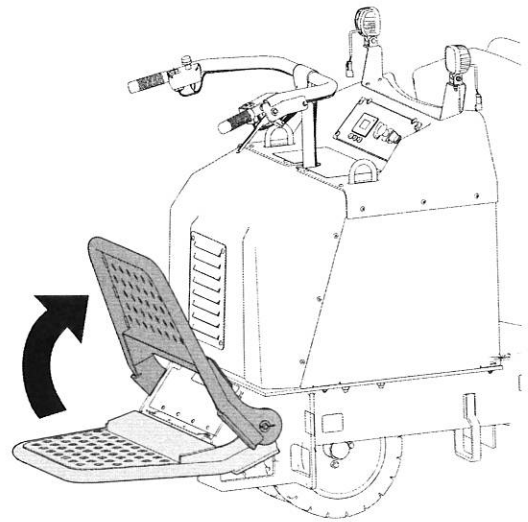

G380478

## Lowering the Platform

1. Push the platform forward to release pressure on the latch pin.
2. Pull the latch pin out and lower the platform.

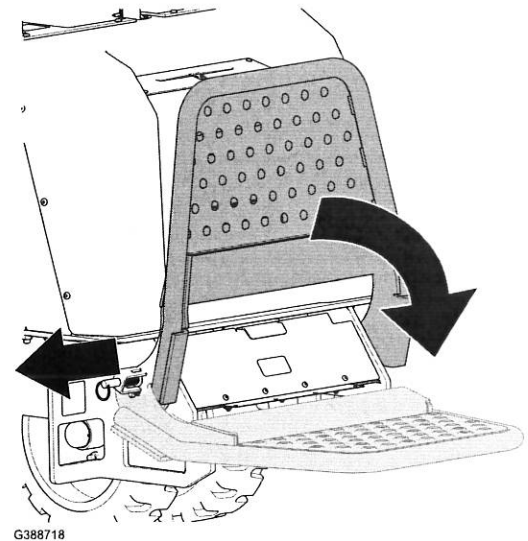

G388718

## Operating the Hopper

---

### IMPORTANT

---

Do not exceed the load capacity of the machine.

---



## Operating the Hopper (continued)

1. Position the machine where you intend to dump the load.
2. Dump the hopper by pushing the switch forward ①.
3. Lower the hopper by pulling the switch rearward ②.

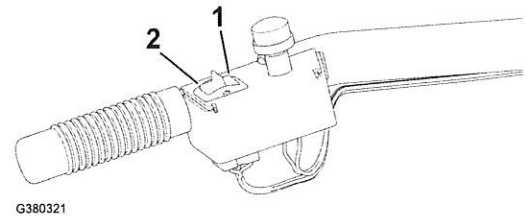

**Note:** Pull the switch rearward twice to engage auto-return.

To stop the automatic movement, push on the hopper switch in any direction.

## After Operation

### After Operation Safety

#### After Operation General Safety

- Engage the parking brake (if applicable), shut off the machine, remove the key, and wait for all movement to stop before adjusting, cleaning, or repairing the machine.
- Do not touch parts that may be hot from operation. Allow them to cool before attempting to maintain, adjust, or service the machine.
- Clean debris from drives and the motor to help prevent fires.

### Battery and Charger Safety

- **WARNING:** Risk of fire and electric shock—The batteries have no user-serviceable parts.
- Confirm the voltage that is available in your country before using the charger.
- Do not get the charger wet; keep it protected from rain and snow.
- A risk of fire, electric shock, or injury may result from using an accessory not recommended or sold by Toro.
- To reduce risk of a battery explosion, follow these instructions and the instructions for any equipment that you intend to use near the charger.
- Batteries could emit explosive gasses if they are significantly overcharged.
- Refer to an Authorized Service Dealer to service or replace a battery.
- Never allow children or untrained people to operate or service the charger. Local regulations may restrict the age of the operator. The owner is responsible for training all operators and mechanics.
- Never allow children or untrained people to operate or service the charger. Local regulations may restrict the age of the operator. The owner is responsible for training all operators and mechanics.
- Keep bystanders and children away while charging.

## After Operation Safety (continued)

- Wear appropriate clothing while charging, including eye protection; long pants; and substantial, slip-resistant footwear.
- Shut off the machine and wait until the machine has completely powered down before charging. Failure to do this may cause arcing.
- Ensure that the area is well ventilated while charging.
- The charger is for use on only nominal 120 to 240 VAC operation. For use with 240 V circuits, contact your Authorized Service Dealer for the correct power cord.
- Do not charge a frozen battery.
- Do not abuse the cord. Do not yank on the power supply cord to disconnect the charger from the receptacle. Keep the cord from heat, oil, and sharp edges.
- Connect the charger directly to a grounding receptacle. Do not use the charger on an ungrounded outlet, even with a grounding adapter.
- Do not alter the provided power cord or plug.
- Remove metal items such as rings, bracelets, necklaces, and watches when working with a lithium-ion battery. A lithium-ion battery can produce enough current to cause a severe burn.
- Never operate the charger without good visibility or light.
- Use an extension cord capable of handling 15 A or more. If you are charging outdoors, use an extension cord rated for outdoor use.
- If the power supply cord is damaged while it is plugged in, disconnect the cord from the wall receptacle and contact an Authorized Service Dealer for a replacement.
- Unplug the charger from the electrical outlet when not in use, before moving it to another location, or prior to servicing it.
- Do not disassemble the charger. Take the charger to an Authorized Service Dealer when service or repair is required.
- Unplug the power cord from the outlet before starting any maintenance or cleaning to reduce risk of electric shock.
- Maintain or replace safety and instruction labels as needed.
- Do not operate the charger with a damaged cord or plug. Contact an Authorized Service Dealer to obtain a replacement cord.
- If the charger has received an impact, been dropped, or otherwise damaged, do not use it; take it to an Authorized Service Dealer.

## Lowering the Hopper without Power

1. Install the cylinder lock.